

---

# use & care guide

---

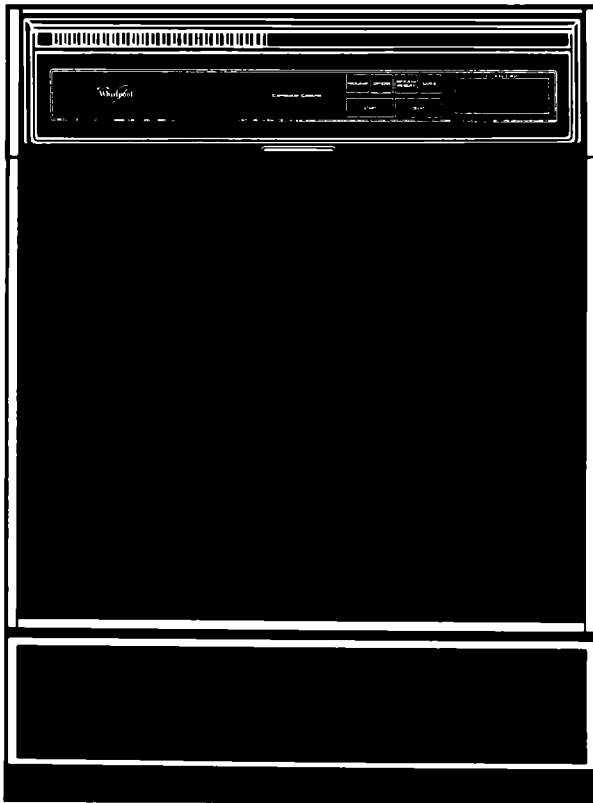

## UNDERCOUNTER DISHWASHER

Model DU9700XR

---

Freezers, Refrigerator-Freezers, Ice Makers, Dishwashers, Built-In Ovens, and Surface Units, Ranges, Microwave Ovens, Trash Compactors, Room Air Conditioners, Dehumidifier

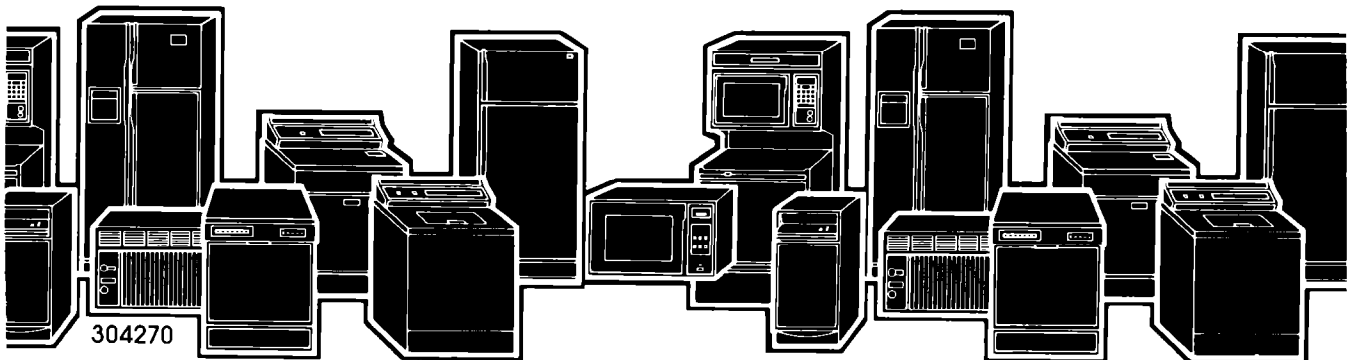

# Contents

	Page		Page
<b>BEFORE YOU USE YOUR DISHWASHER</b> .....	2	Using Program Memory .....	10
<b>IMPORTANT SAFETY INSTRUCTIONS</b> .....	2	Changing or Cancelling a Program ..	11
<b>PARTS AND FEATURES</b> .....	3	Electronic Display and	
<b>POWER CLEAN* WASHING SYSTEM</b> .....	4	Status Indicators .....	11
<b>PROPER LOADING</b> .....	5	Lock-Out Pad .....	12
Top Rack Loading .....	5	Adding a Dish After Starting .....	12
Bottom Rack Loading .....	6	<b>ENERGY SAVING TIPS</b> .....	13
Loading Silverware and		<b>SPECIAL TIPS</b> .....	14
Cutlery Baskets .....	6	<b>COMMON DISHWASHING PROBLEMS</b> ..	15
<b>ADDING DETERGENT</b> .....	7	<b>IF YOU NEED SERVICE OR ASSISTANCE</b> ..	17
<b>RINSE AID DISPENSER</b> .....	7	1. Before Calling for Assistance .....	17
<b>STARTING YOUR DISHWASHER</b> .....	8	2. If You Need Assistance .....	18
Selecting a Program .....	8	3. If You Need Service .....	18
Selecting an Option .....	10	4. If You Have a Problem .....	18

\*Tmk.

©1986 Whirlpool Corporation

## Before you use your dishwasher



It is your personal responsibility and obligation to be sure your dishwasher:

- Is installed by a qualified installer.
- Has been installed where it is protected from the elements.
- Has been installed on a floor strong enough to support its weight.
- Has been properly connected to electricity, water and drain.
- Has been properly electrically grounded.
- Is not used by children or anyone unable to operate it properly.
- Is properly maintained.

See installation instructions for complete information.

## Important safety instructions



**WARNING** – When using your dishwasher, follow basic precautions, including the following:

1. **Read all instructions before using the dishwasher.**
2. **DO NOT** let children play in or on the dishwasher.
3. **DO NOT** reach into the area below the bottom rack until the Heating Element has cooled for at least 20 minutes.
4. **DO NOT** wash plastic items unless marked "Dishwasher Safe" or the equivalent. If not marked check manufacturer's recommendations.
5. Store dishwasher detergent in a cool, dry place WHERE CHILDREN CAN'T REACH IT.
6. Use **ONLY** detergents and rinse aids recommended for use in a dishwasher.
7. **REMEMBER**, use your dishwasher only for the job it was designed to do.
8. Locate sharp items and knives so that they are not likely to damage door seal or cut the user.
9. Properly connect to electricity and water.
10. **DISHWASHER MUST BE ELECTRICALLY GROUNDED.** Read the Installation Instructions for details.
11. **DO NOT** use your dishwasher unless all enclosure panels are properly in place.
12. Be sure your dishwasher is installed on a level floor that will hold the weight, and in an area suitable for its size and use.
13. **DO NOT** sit or stand on or abuse the dishwasher door or dish racks.
14. **DO NOT** tamper with controls.
15. When discarding an old dishwasher, always remove the door to prevent accidental entrapment.
16. **WARNING:** If hot water has not been used recently (usually two weeks or longer), hydrogen gases may build up in the water heater and the hot water pipes. **HYDROGEN GAS IS EXPLOSIVE.** To prevent injury or damage, before using your dishwasher, turn on all hot water faucets and allow water to run for several minutes. This will allow gases to escape. Do not smoke or use any open flame near the faucet while it is open.
17. **WARNING:** Disconnect electrical power to the dishwasher before attempting to service.

– SAVE THESE INSTRUCTIONS –

# Parts and features

Model DU9700XR

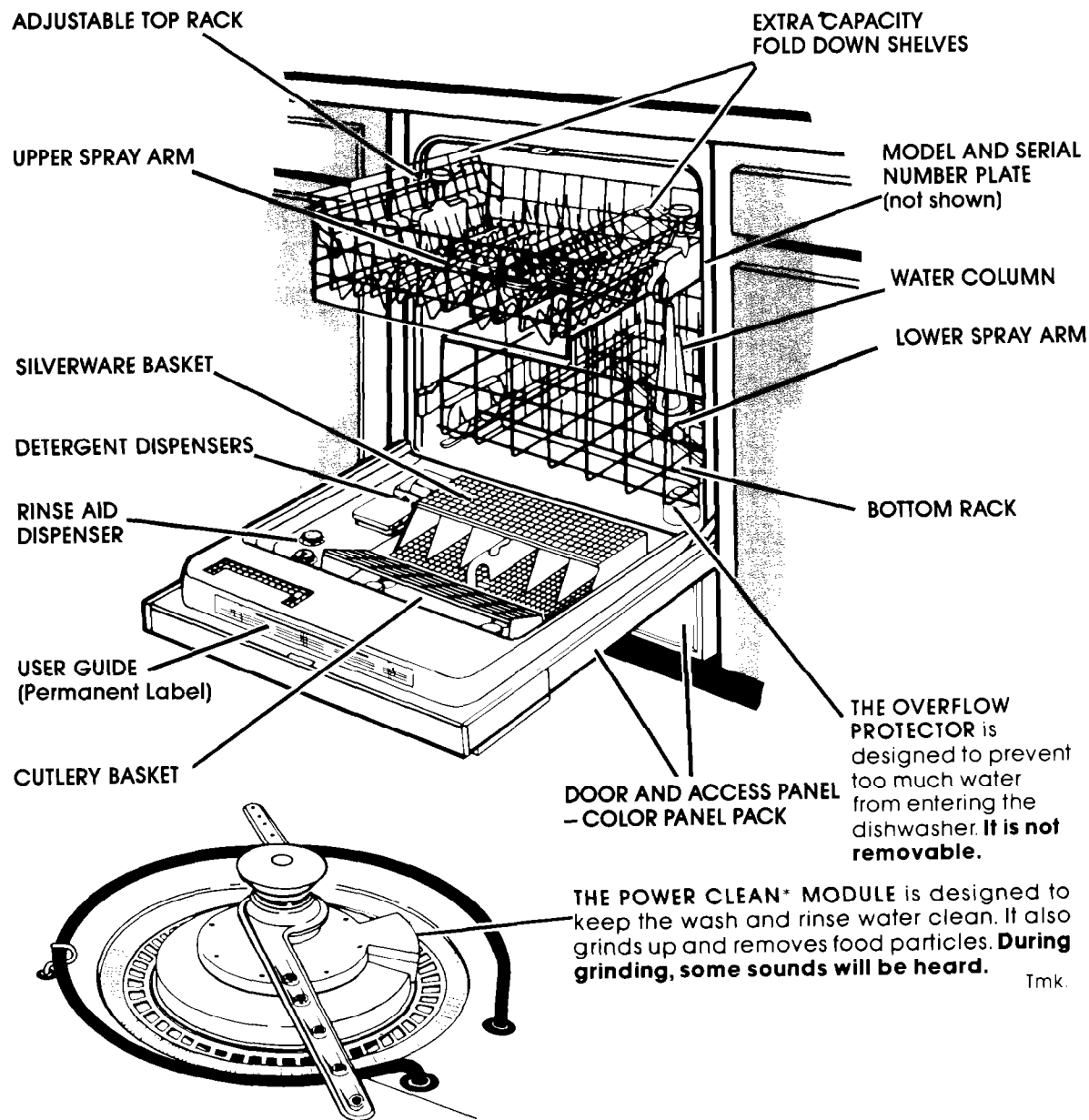

THE OVERFLOW PROTECTOR is designed to prevent too much water from entering the dishwasher. **It is not removable.**

THE POWER CLEAN\* MODULE is designed to keep the wash and rinse water clean. It also grinds up and removes food particles. **During grinding, some sounds will be heard.** Tmk.

BEFORE YOU USE • SAFETY • PARTS AND FEATURES

## Copy your Model and Serial Numbers here...

When you need service or call with a question, have this information ready:

1. **Complete** Model and Serial Numbers (from the plate located as shown).
2. Purchase date from sales slip.

Copy this information in these spaces. Keep this book, your warranty and sales slip together in a handy place.

**Please complete and mail the Owner Registration Card furnished with this product.**

\_\_\_\_\_

Model Number

\_\_\_\_\_

Serial Number

\_\_\_\_\_

Purchase Date

\_\_\_\_\_

Service Company and Telephone Number

# POWER CLEAN\* Washing System

Your dishwasher cleans by spraying a mixture of hot, clean water and detergent against soiled surfaces of dishes. When a cycle is started, the dishwasher fills with water to about the level of the heating element. This water is pumped through the rotating spray arms, through the POWER CLEAN Module which removes food particles, and back through the rotating spray arms. Soiled water is pumped out and replaced with clean water during a cycle – the number of times depends on the cycle being used.

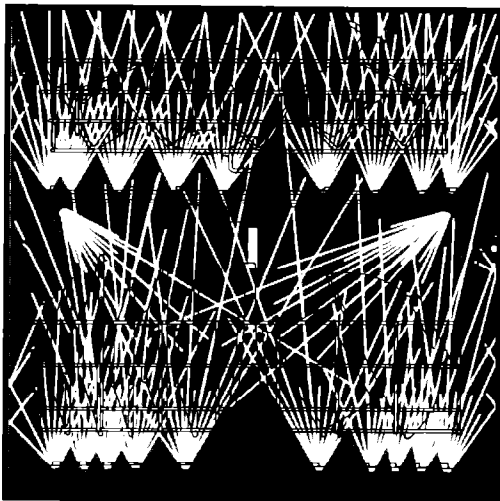

Load dishes so soiled surfaces face powerful spray from rotating arms.

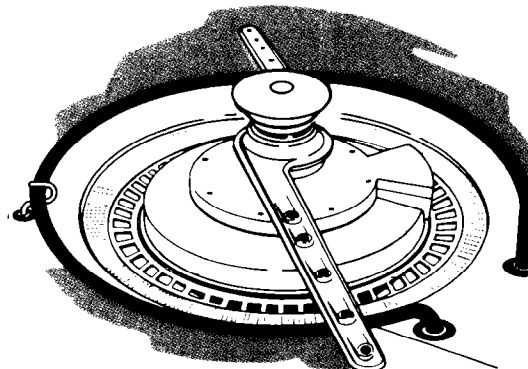

The POWER CLEAN\* Module removes food particles from the water, stores them, then washes them down the drain.

## Step-saving preparation for washing

**It is not necessary to rinse dishes before putting them into the dishwasher.** Just remove large pieces, bones, and other hard items. The POWER CLEAN\* Module will remove food particles from the water. It contains a chopping device which will reduce the size of food items.

If hard items such as fruit seeds, nuts and egg shells enter the POWER CLEAN\* Module, you

might hear chopping, grinding, crunching or buzzing sounds. Those sounds are normal when hard items enter the module. **DO NOT LET METALLIC ITEMS (I.E. POT HANDLE SCREWS) GET INTO THE POWER CLEAN\* MODULE. THIS COULD RESULT IN DAMAGE TO THE POWER CLEAN\* MODULE.**

## Hot water is a must

Hot water dissolves and activates the dishwashing detergent. Hot water dissolves grease on dishes and helps dry glasses spot-free. Make certain loads are washed in hot water (at least 140°F – 60°C). Two ways to have a reliable hot water supply...

1. Maintain 140°F water supply at central water heater. To check water temperature, turn on hot water faucet nearest the dishwasher. Let water run until it is as hot as possible, then check with a candy or meat thermometer. If

the temperature is too low, have a qualified person raise the water heater thermostat setting.

2. Use HI-TEMP WASHING Option. If water heating is needed, a thermostat will delay the cycle until temperature reaches 145°F (63°C). If water is hot enough, the cycle will proceed with no delay. This lets you turn down your water heater, if you choose, without cutting back on hot water needed for good dishwashing.

## Quiet operating tips

To avoid thumping and clattering noises during operation:

- Make sure lightweight load items are secured in the rack.
- Make sure pot lids and handles, pizza pans, cookie sheets, etc. do not touch interior walls

or interfere with either of the spray arms rotation.

- Load dishes so they **don't** touch one another.
- NOTE: Keep sink drain plugs inserted during dishwasher operation to prevent noise transfer through drains.**

## Proper loading

Always load dishes so soiled surfaces are reached by spray from rotating spray arms. Water must be able to drain off completely for best drying results. Be careful to separate items so spray can reach all surfaces.

### Top rack loading

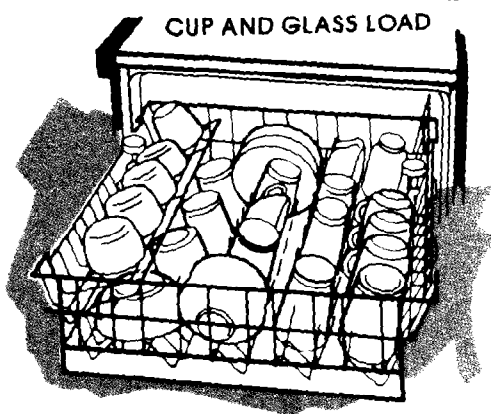

The top rack is designed for cups, glasses and smaller items.

- Place so open ends face down for cleaning and draining.
- **Load glasses in top rack only.** Bottom rack is not designed for glasses. Damage may occur.

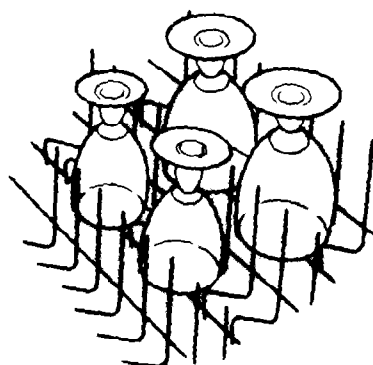

- Place items in the rows **between** prongs. Placing them **over** the prongs can lead to breakage.
- Be sure lightweight items are held firmly in place.
- China, crystal and other delicate items must not touch each other during dishwasher operation. Damage may occur.

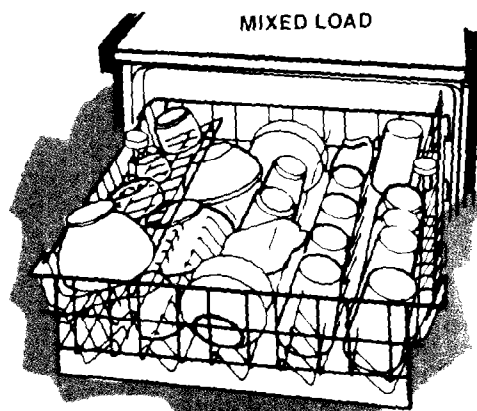

- Load plastic items **only in the top rack.** Only plastic items marked "dishwasher safe" are recommended.
- Plastic items can be melted in the bottom rack.
- Small bowls, pans and other utensils can be placed in the top rack.
- Items with cooked-on or dried-on foods should be loaded in the bottom rack with soiled surfaces facing the spray.

### ADJUSTABLE TOP RACK

The top rack does not have to be level.

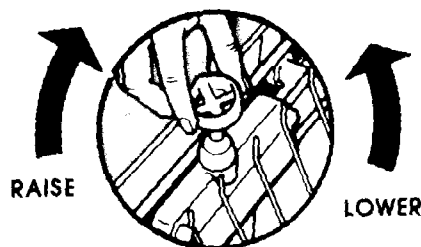

- Raise or lower one or both sides to help fit tall items in the top or bottom rack.
- Turn knob clockwise to raise a side.
- Turn knob counterclockwise to lower a side.

### EXTRA CAPACITY FOLD DOWN SHELF

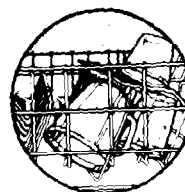

Fold down shelves on the right and left side of the top rack can be folded down over short items (cups, juice glasses, cereal bowls, etc.) to hold extra items. Adjust rack height if necessary (see above).

## Bottom rack loading

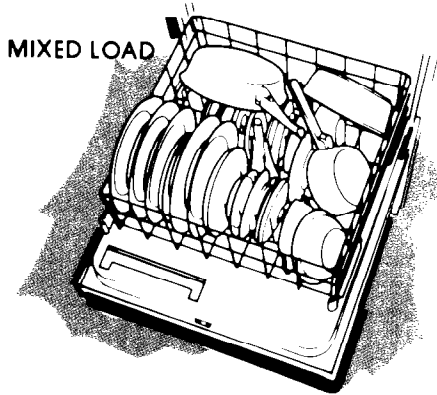

- Place plates, soup bowls, etc., **between** prongs and facing the spray.
- Securely place heavily soiled cookware face down in rack.

### NOTE:

- Do not load glasses, cups or plastic items in the bottom rack.
- When lower rack is removed, replace with bumpers in front.

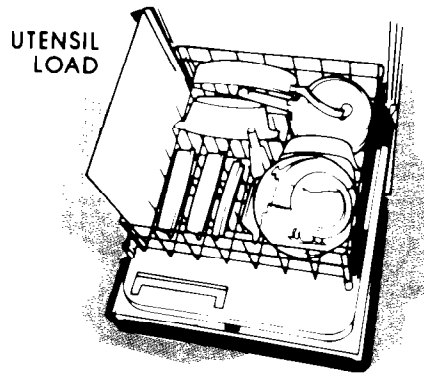

- Load cookie sheets, cake pans and other items at sides or back. Loading items in front may keep water spray from reaching detergent dispenser and silverware basket.
- Make sure pot handles and other items do not stop rotation of either the upper or lower spray arm. Spray arms must move freely.

## Loading silverware and cutlery baskets

Load forks and spoons so they **don't nest together**. Spray can't reach nested items.

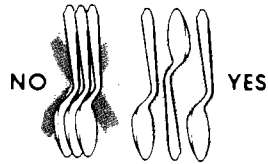

Mix items in each section of the basket. Make sure sharp items (knives, forks, skewers, etc.) are put in point down.

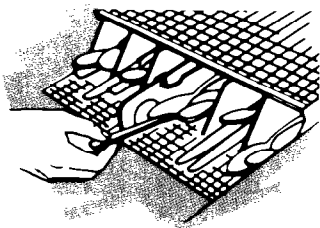

The silverware basket can be loaded while it's in place on the door, or it can be taken out for loading on the counter or table.

It can also be removed for easy unloading. Always unload or remove the basket before unloading the racks to avoid spilling water droplets on the silverware.

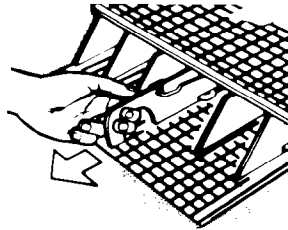

**To remove the basket**, slide it toward the top of the door—by the handle. Lift it off the holding buttons. Replace it in reverse order.

**To open the basket**, unhook the latch as shown. Be sure the cover is completely latched before pulling out the bottom rack and before closing the dishwasher door.

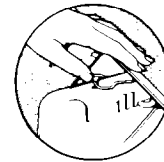

Remove and replace the cutlery basket in the same way as the silverware basket. Use the cutlery basket for long items. Remove the basket and tip contents onto a cutting board to unload. This can help avoid accidents with sharp points and edges.

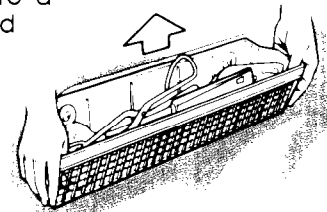

## Adding detergent

The kind and amount of dishwasher detergent you use is an important part of getting your dishes clean. Read this section carefully.

### Use automatic dishwasher detergent only.

Other detergents are too mild and much too sudsy to work in the dishwasher.

Different brands of dishwasher detergent have different amounts of phosphorus. Phosphorus softens water and helps prevent water spots on dishes.

If water is hard and phosphorus content is low (8.7% or less), you may need to use more detergent or use a brand with a higher phosphorus content (12% or higher).

Do not add detergent until you are ready to wash. When using Delay Wash, make sure the detergent dispensers are clean and dry before adding the detergent. **Fresh automatic dishwasher detergent is necessary for best washing results.** Store detergent tightly in a cool dry place.

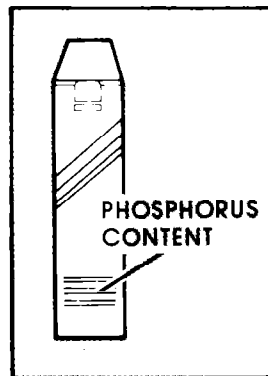
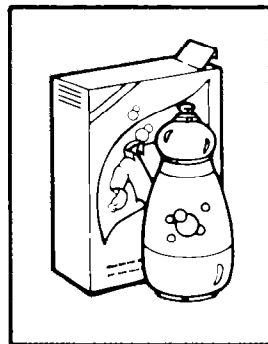

### The detergent dispenser

The detergent dispenser has one section with a cover and one without.

- Put detergent in both sections for cycle programs with two washes.
- Put detergent in the covered section only for cycle programs with one wash.
- Push the cover down until it is latched.

The cover opens automatically when the main wash starts. Detergent in the open section falls into the dishwasher when the door is closed.

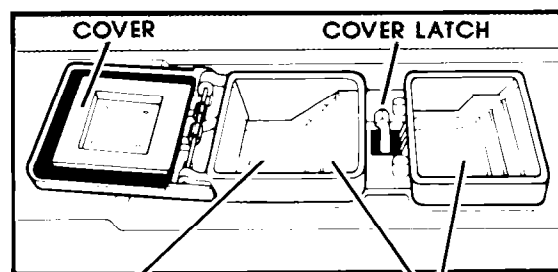
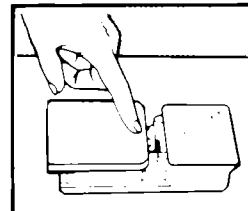

Use covered section for...  
**NORMAL,**  
**LOW ENERGY** and  
**CHINA** Programs

Use both sections for...  
**POTS & PANS** and  
**HEAVY** Programs

## How much detergent to use

The amount of detergent to use depends on the hardness of your water. If too little is used, dishes won't be clean. However, if too much is used in soft water, glassware will begin to etch.

Find out your water's hardness by asking your local water department, water softener company or county extension agent.

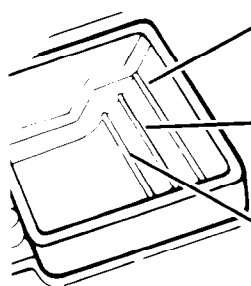

- **HARD** – Fill 1 or both sections to top line if water is 8 or more grains of hardness.
- **MEDIUM** – Fill 1 or both sections to middle line if water is 5 to 7 grains of hardness.
- **SOFT** – Fill 1 or both sections to bottom line if water is 0 to 4 grains of hardness.

## Rinse aid dispenser

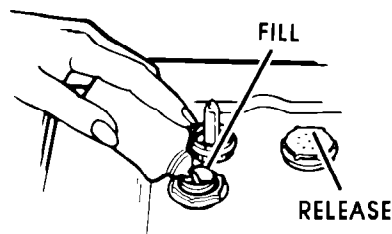

A rinse aid helps keep water from forming droplets and drying as spots. Keep the dispenser filled with a rinse aid such as Jet-Dry®. A small amount is released automatically during the final rinse of each cycle. Check the dispenser periodically to see if it needs refilling.

The **Fill Indicator Cap** shows when it's time to fill the rinse aid dispenser. When the fill level is low, the center of the cap will appear to be clear.

Keep the dispenser fill cap tightly closed.

# Starting your dishwasher

Six program pads, a hidden LOCK-OUT pad and the electronic display allow you to program and monitor the dishwasher's operation. A programming tone sounds each time a pad is touched under normal operation.

When first installed, "PF" will show on the display. Press CANCEL pad **twice** to clear the display. **To start the dishwasher**, press the PROGRAM pad. The dishwasher is pre-programmed for the NORMAL program with the AIR DRY option. If you want this program, touch START.

**To select a different program and/or option**, just touch the PROGRAM and/or OPTION pad until the program and/or option you desire appears in the display. Each touch of the pad advances the display to the next program or option. After each use, the dishwasher remembers the program and options used. **Ex:** The next time the display is lit up for programming, it will show the last cycle that was run.

**When dishes are loaded and ready to be washed...**

1. Spin the Upper Spray Arm to make sure nothing will stop it from turning.
2. Close and latch the door.
3. Run hot water at the sink nearest the dishwasher until it is hot.
4. Select a desired program by touching the PROGRAM pad.
5. Select an Option by touching the OPTIONS pad.
6. Touch START pad.

## Selecting a program

POTS & PANS  
HEAVY  
NORMAL  
LOW ENERGY  
CHINA RINSE

### POTS & PANS

Maximum cleaning for cooked-on or baked-on foods. The program time delays while the dishwasher automatically heats the water to 145°F (63°C) in both washes and the last rinse (marked \*). *Program time\*\** is 77 minutes plus the time needed to heat the water.

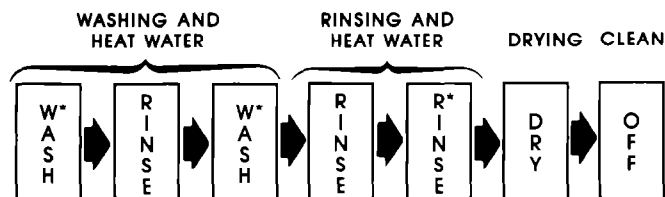

### HEAVY

A double wash for heavily soiled loads. *Program time\*\** is 73 minutes.

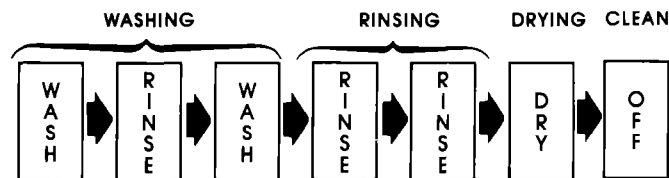

### NORMAL

For normal, everyday soiled loads. (The Energy Guide Label data is based on this program.) *Program time\*\** is 72 minutes.

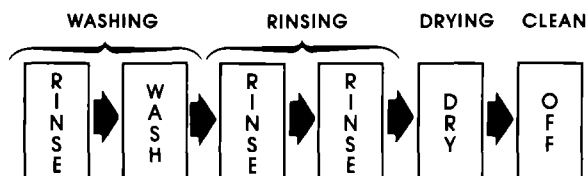

\*\*Program time includes heated dry times. 30 minutes less time is required with AIR DRY selected.

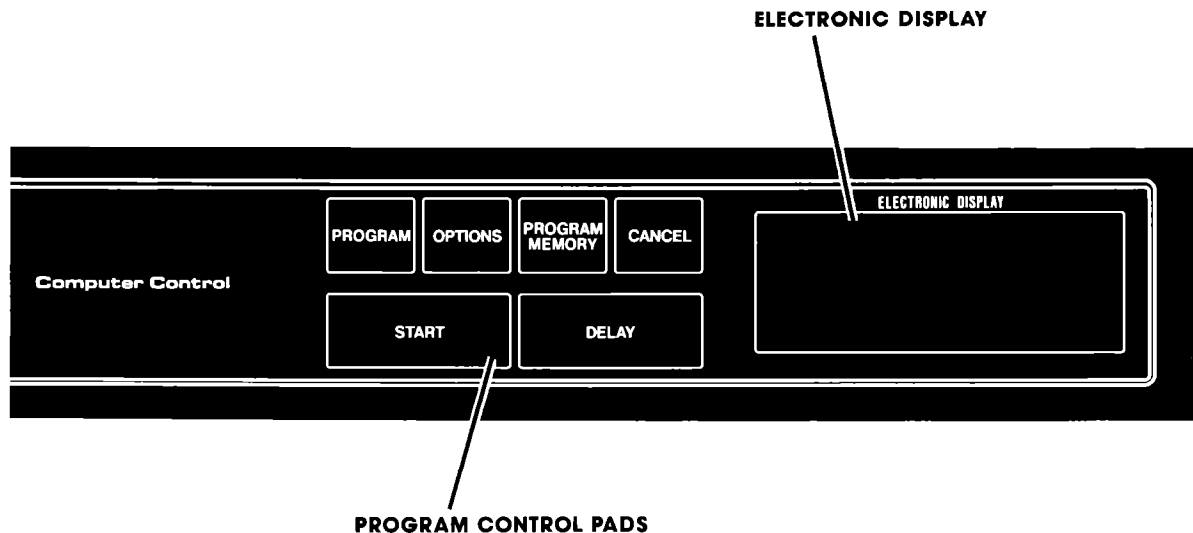

### LOW ENERGY

For pre-rinsed or lightly soiled loads. Program time\* is 56 minutes.

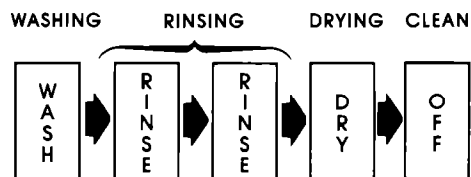

### CHINA

A light wash and gentle dry for china and crystal. The heating element cycles on and off during the "dry" part of the program when HEAT DRY is selected. Program time\* is 53 minutes.

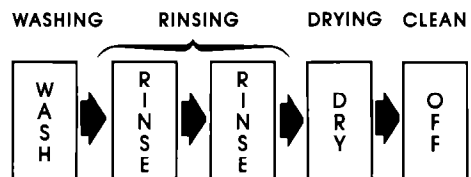

### RINSE

For rinsing a few items to be washed one or more days later. Program time is 12 minutes.

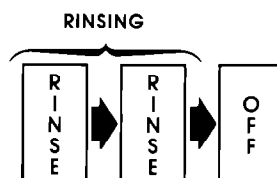

\*Program time includes heated dry times. 30 minutes less time is required when AIR DRY is selected.

## Selecting an option



### AIR DRY

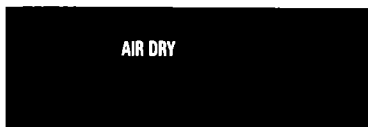

The AIR DRY option helps save energy, but the dishes take longer to dry (overnight). Some water spotting may result. Some items (such as plastics) may need towel drying. For best results, use a liquid rinse aid such as Jet-Dry.<sup>®</sup>

### HEAT DRY



When HEAT DRY is selected, the air in the dishwasher is heated during the "dry" portion of any program – except RINSE.

### HI TEMP



When HI TEMP is selected, the water for the main wash and final rinse is heated to 145°F (63°C). POTS & PANS has the HI TEMP option pre-programmed into it. HI TEMP can not be selected with RINSE or CHINA programs.



A Dry Option will show in the display with HI TEMP. Be sure to select the desired Dry Option (HEAT DRY or AIR DRY) in combination with HI TEMP.

- Touch OPTIONS pad until HI TEMP indicators are shown in the display.
- Option indicators will not show in the display if they cannot be selected with a program; RINSE, POTS & PANS or CHINA.
- You can change an option while the program is running by touching the OPTIONS pad.

Options can be selected by touching the OPTIONS pad. Each touch of the pad advances the display to the next option. There are three options available: AIR DRY, HEAT DRY and HI TEMP. All options can be changed any time the display is on, including during a program. When the RINSE program is selected, options are not available. When POTS & PANS or CHINA program is selected, only HEAT DRY and AIR DRY options are available.

## Using PROGRAM MEMORY

The use of PROGRAM MEMORY lets you store the complete dishwashing program that you most frequently use.



### To set PROGRAM MEMORY for the first time:

1. Touch PROGRAM MEMORY pad once. The PROGRAM indicator will show on the display.
2. Select the dishwashing Program, Options and Delay Hours. This is done by touching the PROGRAM, OPTIONS and DELAY pads.
3. Touch PROGRAM MEMORY pad a second time. This enters the selected Program, Options and Delay Hours into the dishwasher's memory.  
**NOTE: Each step must be completed within 15 seconds. If not completed in 15 seconds, the display will go blank.**

### To start the dishwasher using PROGRAM MEMORY:

- Touch START. The dishwasher will immediately start. **If Delay Hours are in the Program Memory, the dishwasher will start the delay count down.**

### To change the dishwashing program in PROGRAM MEMORY:

1. Touch PROGRAM MEMORY pad once. The display will show the set Program, Options and Delay Hours (if selected).
2. Touch in the new Program, Options and/or Delay Hours you want. **NOTE: If you want to cancel Delay Hours, the hours must be advanced to the blank that comes after the 9.**
3. Touch PROGRAM MEMORY pad a second time. This enters the selected Program, Options and Delay Hours into the dishwasher's memory. **NOTE: Each step must be completed within 15 seconds. If not completed in 15 seconds, the old Program, Options and Delay Hours will remain as they were.**

### In case of a power interruption or failure:

The PROGRAM MEMORY will be erased. Reset the PROGRAM MEMORY for the Program, Option and Delay Hours you want.

## DELAY Pad



The DELAY pad allows you to delay the start of the dishwasher from 1 up to 9 hours. Each touch of this pad adds another hour of delay to the digital display. After 9 hours, touching the DELAY pad will change the display **back to 1 hour**. The DELAY HOURS indicator will show on the display.

**To start the dishwasher during the delay**, touch cancel to cancel the existing program; select desired program, then touch START. The dishwasher will start immediately.

## CANCEL Pad



The CANCEL pad allows you to cancel a program or to clear the display. If the dishwasher is washing, it will go into a 2 minute drain automatically before shutting off. If the dishwasher had not been started, it will clear the display.

## Changing or cancelling a program

### After a program has started, to cancel:

- Touch CANCEL pad once. The dishwasher will automatically drain for 2 minutes, then shut off.

### OR

- Touch CANCEL pad twice. The display will clear and the dishwasher will immediately shut off.

### To restart the dishwasher

- Check detergent dispensers to make sure they are filled properly for the new program.
- Touch START to run the dishwasher in the Program Memory.

### OR

- Select desired program and options, then touch START.

## Electronic display and status indicators

### The electronic display shows...



- The number of minutes **remaining** in a program (60, 59, 58 minutes, etc.) represents the WASHING, RINSING and HEAT DRY times. The program time remains the same while the water is heating.



- The number of delay hours selected (1,2,....,9).

### The display also points out operating problems:



- "PF" shows on the display whenever there has been a power interruption or failure.



- "E4, E2, E1 or E0" show whenever there has been a control panel malfunction.

**Touch CANCEL pad to clear display. The dishwasher may drain before shutting off. If the dishwasher display will not clear or continues to show a code at the end of each cycle, call your TECH-CARE® service technician. (See page 18.)**

**Status indicators** let you know what your dishwasher is doing during a program.



**WASHING** shows on the display during the wash portion of the program. The indicator goes off when the last wash is completed.

**RINSING** shows on the display during the two final rinses before drying.

**DRYING** shows on the display during the dry portion of the program with the HEAT DRY option.

**CLEAN** shows on the display when the program is complete or immediately after the last rinse when AIR DRY is selected. Opening the door or touching CANCEL clears the CLEAN indicator.

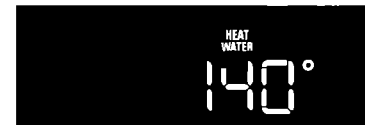

**HEAT WATER** shows on the display whenever the water is being heated in the POTS & PANS program or when HI TEMP option has been selected.

Whenever the dishwasher is heating water, **the digital display will show the water temperature**. When the water reaches the proper temperature, the display will go back to showing the remaining program time. **NOTE: The program time remains the same while the water is heating.**

**DOOR OPEN** flashes on the display when the door is unlatched during dishwasher programming or operation. A tone will also beep twice every 3 minutes for up to 2 hours.

## Lock-out pad

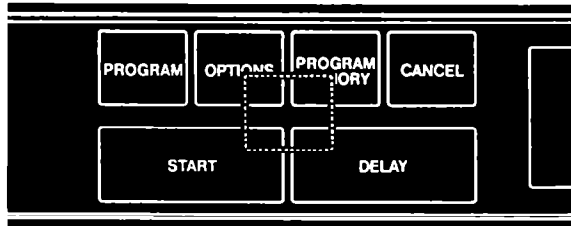

A hidden LOCK-OUT pad is located in the center of the Control Pads. This pad lets you turn off the programming tone or lock-out the function of the Control Pads (except CANCEL).

**When the LOCK-OUT pad is pressed and held for 3 or more seconds**, the programming tone will turn off. The tone will not sound when the pads are touched or when the door is opened. To turn the programming tone back on, press and hold the LOCK-OUT pad for 3 or more seconds.

**When the LOCK-OUT pad is touched twice within 2 seconds**, "L" will show in the digital display (for 2 seconds) and all control pad operations (except CANCEL) and the programming tone will be locked out. If a control pad is touched while in LOCK-OUT, the display will show an "L" for 2 seconds. This shows you that LOCK-OUT is being used. To return the control pads and programming tone to full operation, touch the LOCK-OUT pad twice in 2 seconds. The pads will work again.

### To add a dish after starting

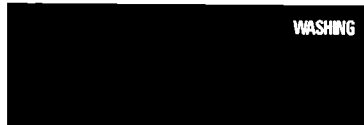

1. To be sure the added item is washed, make sure the WASHING indicator is still on.

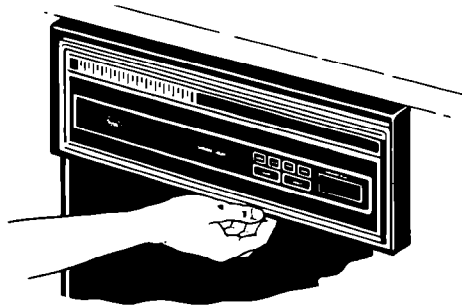

2. To stop the dishwasher, unlatch the door by pushing in the latch handle under the control panel. **Do not** open the door until the spray arms stop spinning. The DOOR OPEN indicator will flash and a tone will beep.

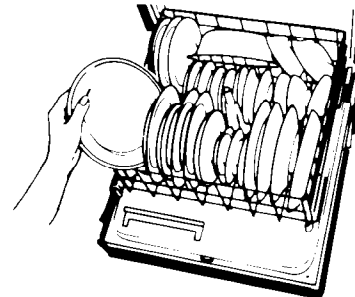

3. Open the door and add the dish.

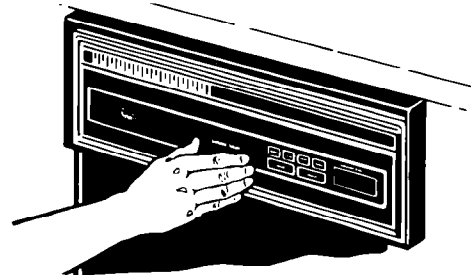

4. Close the door. **Do not latch it.** Wait 30 seconds for air in the dishwasher to warm up. This helps reduce the amount of moisture that can come from the vent when restarting the program.
5. Push in on the door until it latches. The dishwasher will restart and continue the program.

# Energy saving tips

You can help save energy if you:

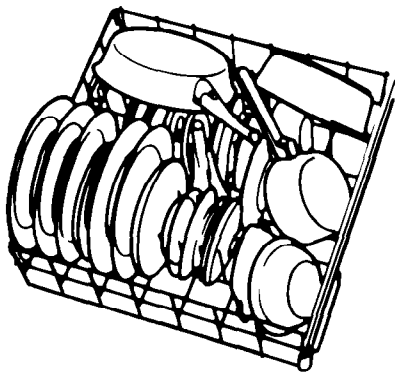

1. **Wash full loads.** Running a half-filled dishwasher uses the same amount of electricity and hot water as a fully loaded machine.



3. **Air dry dishes** when you don't need a rapid drying cycle. Allow longer drying times (overnight).

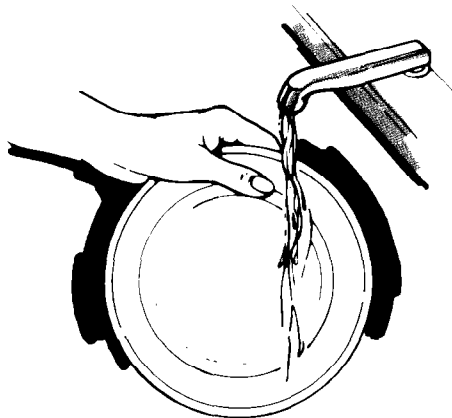

2. **Use the LOW ENERGY or CHINA program** whenever possible. They use less hot water and energy than other programs.

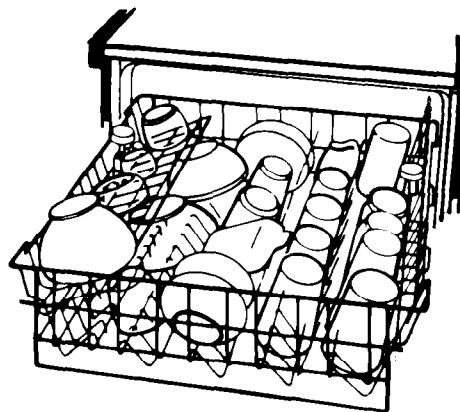

4. **Load correctly** for best washing results. Incorrect loading may cause poor washing and the need to rewash all or part of the load.
5. **Don't pre-rinse normally soiled dishes.** Select the correct program for the load and use the recommended amount of detergent for good washing results without hand rinsing.
6. **Use your dishwasher** during off-peak hours. Local utilities recommend this to avoid heavy usage of energy at certain times of day.
7. **Kitchen cleanup** can be done quickly and efficiently through the use of your dishwasher. Most appliance parts that can fit in the dishwasher can be cleaned by it. Burned-on soil, however, should be cleaned by hand.

# Special tips on dishwasher use

**Remember, use your dishwasher only for the job it was designed to do. Some items are not dishwasher safe or may require special care. Read these special tips for the following items:**

**Aluminum:** Aluminum loses its bright, shiny appearance and darkens in color due to minerals in the water and the alkalinity of the dishwasher detergent. Colored aluminum may fade.

**TIPS:** If washed in the dishwasher avoid placing directly in front of detergent dispenser where it could be sprinkled with undissolved detergent, causing spotting, pitting, and discoloration. Follow utensil manufacturers' cleaning instructions.

**China:** Hand-painted, metal-trimmed, and antique china may fade due to high water temperatures and alkaline detergent solution in the dishwasher.

**TIPS:** **Delicate, antique items should not be washed in the dishwasher.** Load carefully. **Do not** allow pieces to touch each other. Test one piece by washing it daily in the dishwasher for several weeks. Then compare it with the rest of the set to see if colors have changed.

**Crystal and decorative glasses:** Crystal can break from sudden exposure to high water temperature. Metal trim and colorful decoration on glass will fade in time when washed in the dishwasher.

**TIPS:** **Delicate, antique items should not be washed in the dishwasher.** Load carefully in **top rack only**. Be sure to load a few larger items in the bottom rack to reduce amount of force of water spray reaching glassware from lower spray arm. Use the shortest cycle.

**Flatware:** Salty and acidic foods may tarnish silver and stainless flatware if allowed to remain on the utensils. A film may form on sterling silver and silver plate items washed in a dishwasher. This film is caused by reaction of silver with chlorine in the detergent. **Gold flatware is not dishwasher safe.**

**TIPS:** Rinse flatware as soon as possible, especially if it is not to be washed right away. Dishwasher detergent may remove antique finishes. Wash by hand. Tarnish and film build-up can be removed with silver polish.

**Cast iron utensils:** The seasoned finish will be removed in the dishwasher. Rusting will result.

**TIPS:** Wash by hand. To re-season, coat with unsalted fat and heat in a slow oven for an hour or two.

**Plastics:** Many plastics will have "Dishwasher Safe" written on them. Some plastics are heat sensitive and may melt or warp.

**TIPS:** If in doubt, try one piece. Place in upper rack only. AIR DRY option provides additional protection.

**Non-stick finish utensils:** Most can be washed in the dishwasher.

**TIPS:** Follow manufacturers' suggestions.

**Wood:** Many wooden items will crack and warp or lose their finish.

**TIPS:** **Do not wash cutting boards, wooden salad bowls or knives with wooden handles in the dishwasher.**

**Pewter or pewter-like materials:** May streak, discolor, and pit.

**TIPS:** To keep pewter at its very best, hand wash with mild detergent.

## Dishwasher care & cleaning:

**Exterior** – Regular use of a soft damp cloth or sponge and a mild detergent is all that is necessary, in most cases, to keep the outside of your dishwasher nice looking and clean. **Interior** – Hard water minerals may cause a white film to build-up on the inside surfaces, especially just beneath the door area. Wear rubber gloves when cleaning the dishwasher interior. **Do not use any type of cleanser other than dishwasher detergent because it may cause foaming or sudsing.**

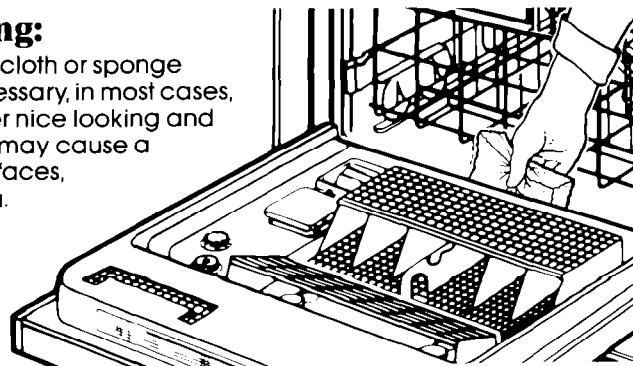

# Common dishwashing problems

PROBLEM	CAUSED BY	SOLUTION
<b>Spotting and filming</b> (hard water film)	Hard water	Fill detergent dispensers to capacity. Use dishwasher detergent with highest available phosphorus content. May be necessary to install water softener. To remove spots and film, try a vinegar rinse... 1. Wash and rinse load as usual. Use AIR DRY. 2. Remove all metal items. 3. Put 2 cups (500 mL) white vinegar in a container on the bottom rack. 4. Run dishwasher through a complete washing cycle.
	Water is not hot enough	Water temperature should be at least 140°F (60°C). Set water heater thermostat to a higher setting. Run water at sink until hot before starting and/or use HI-TEMP WASH Option.
	Not enough detergent, or improper detergent "Old" detergent	Use more dishwasher detergent. Use detergent with highest available phosphorus content...especially with hard water. Use only fresh dishwasher detergent. Store <b>tightly closed</b> container, in cool, dry place. Discard old detergent. Do not fill dispensers until ready to start dishwasher.
	Improper loading	Make sure dishes and glassware are loaded so spray reaches all surfaces and items drain properly. Do not overload. Do not nest items. Make sure large items do not block spray from reaching detergent dispensers.
	No rinse aid	Does the rinse aid dispenser need filling? See instructions on page 7.
	AIR DRY Setting used	Drying without heat may result in some spotting of glasses and silver.
<b>Small particles deposited on items</b>	Spray arm or arms not rotating freely "Old" detergent	Check spray arms to make sure they turn freely after loading. Be sure a utensil has not prevented their turning. Use only fresh dishwasher detergent. Store <b>tightly closed</b> container, in cool, dry place. Discard old detergent. Do not fill dispensers until ready to start dishwasher.
	Not enough detergent, or improper detergent	Use more dishwasher detergent. Use detergent with highest available phosphorus content...especially with hard water.
	Water is not hot enough	Water temperature should be at least 140°F (60°C). Set water heater thermostat to a higher setting. Run water at sink until hot before starting and/or use HI-TEMP WASH Option.
	Water pressure may be low, dishwasher is not filling properly	If water pressure is low, do not use water for other purposes while dishwasher is running (to assure correct fills).
	<b>Dishes not dry</b>	Water is not hot enough
Improper loading		Make sure dishes and glassware are loaded so spray reaches all surfaces and items drain properly. Do not overload. Do not nest items.
No rinse aid		Fill rinse aid dispenser.
AIR DRY Setting used		Allow more time when using AIR DRY Option, or use HEAT DRY. Plastic items may need towel drying.
<b>Black marks on dishes</b>	Aluminum utensils rubbing against items during washing	<b>Use care in loading aluminum utensils, especially a lightweight foil container. Place so it does not touch dishes.</b> Remove black marks with plastic scouring pad and a mild abrasive cleanser.
<b>Chipping or breaking glassware</b>	Improper loading	Do not overload. Load glasses in the top rack only. Load between prongs, not over them. Glasses loaded over prongs will not be supported and may chip or break.

<b>PROBLEM</b>	<b>CAUSED BY</b>	<b>SOLUTION</b>
<b>Dishes not washing clean</b>	Water is not hot enough	Water temperature should be at least 140°F (60°C). Set water heater thermostat to a higher setting. Run water at sink until hot before starting and/or use HI-TEMP WASH Option.
	Improper loading	Make sure dishes and glassware are loaded so spray reaches all surfaces and items drain properly. Do not overload. Do not nest items. Make sure large items do not block spray from reaching detergent dispensers.
	Spray arm or arms not rotating freely	Check spray arms to make sure they turn freely after loading. Be sure a utensil has not prevented their turning.
	Not enough detergent or improper detergent "Old" detergent.	Use more dishwasher detergent. Use detergent with highest available phosphorus content...especially with hard water. Use only fresh dishwasher detergent. Store <b>tightly closed</b> container, in cool, dry place. Discard old detergent. Do not fill dispensers until ready to start dishwasher.
	Water pressure may be low, dishwasher is not filling properly	If water pressure is low, do not use water for other purposes while dishwasher is running (to assure correct fills).
<b>Cloudy film on glassware, etching – permanent corrosion</b>	Too much detergent in soft water	Check for rainbow hue on glasses. A rainbow hue is the first sign of etching (corrosion of glass). Reduce the amount of dishwasher detergent. Use a detergent with a lower phosphorus content.
	Inadequate rinsing	If water pressure is low do not use water for other purposes while dishwasher is running (to assure correct water fills). Make sure dishes and glassware are loaded properly to assure adequate rinsing and draining. Do not overload.
<b>Dishes &amp; interior of dishwasher yellow or brown</b>	Iron or manganese in water	<b>Temporary remedy:</b> 1. Set empty dishwasher for a "one wash" cycle. 2. Start dishwasher and unlatch door to stop it when it has filled for the wash part of the cycle. 3. Add ¼ to ½ cup (120 to 240 mL) of citric acid crystals (usually available in drugstores). 4. Close and latch door to complete cycle. <b>Permanent solution:</b> Install an iron or manganese filter to home water supply.
<b>Rust spots on stainless steel –OR- Dark spots on flatware – stainless steel, silver plate, or sterling</b>	Allowing salty or acidic foods such as mayonnaise, vinegar, fruit juices, salad dressings, milk products to remain on flatware. Undissolved detergent coming in contact with flatware	Rinse flatware that is to stand for several hours before washing. Clean stained items with silver polish and re-wash. <b>Do not put stainless steel and silver flatware in the same silverware basket compartment. Direct contact between these metals can cause permanent damage to the silver.</b> Remove spots with silver polish. Avoid spilling concentrated detergent on wet flatware.
	<b>Bronze tarnish on silverplate</b>	Silverplate is worn off. Exposed base metal takes on a bronzed hue. Remove tarnish with silver polish. Have silver replated.
<b>Water left in bottom of dishwasher</b>	Dishwasher cycle not completed	Allow dishwasher to complete cycle.
	Clogged drain air gap	Some plumbing codes require use of a drain air gap between an <b>undercounter</b> dishwasher and the drain system of the house. The air gap is usually located above the sink or on the top of the counter near the dishwasher to prevent the possibility of water backing up from the drain into the dishwasher due to a plugged drain. The drain air gap is <b>NOT</b> a part of the dishwasher and is <b>NOT</b> covered by the dishwasher warranty. The drain air gap should be kept clean to insure proper draining of the dishwasher.

## **If you need service or assistance, we suggest you follow these four steps:**

### **1. Before calling for assistance...**

Performance problems often result from little things you can find and fix yourself without tools of any kind.

#### **If your dishwasher will not run, or stops during program:**

- Is the door tightly closed and securely latched?
- Has the program been correctly set (and the START pad pressed)?
- Is the water turned on?
- Have you checked your home's main fuses or circuit breaker box?
- Is the dishwasher wired into a live circuit with the proper voltage (undercounter models)?
- If the motor has stopped because of an overload, it will automatically reset itself within a few minutes. If motor does not start, call for service.

#### **If water remains in the dishwasher:**

- Has the door been left ajar?
- Has the program completed?
- Touch CANCEL. The dishwasher will automatically go into a 2 minute drain period.

#### **If detergent remains in the covered detergent cup:**

- Is the bottom rack in backwards? (The rack bumpers should be at the front.)
- Is the dishwasher detergent fresh?
- Has the program completed?

#### **If you hear grinding, grating, crunching, buzzing sounds:**

- A hard object has probably entered the POWER CLEAN Module. The sound should stop when the object is ground up.

#### **If "L" appears in the display or Pads won't program:**

- The hidden LOCK-OUT pad has been turned on. Touch LOCK-OUT pad twice within 2 seconds to turn off. (See page 12.)

#### **If the programming tone does not beep, or is only heard when CANCEL pad is touched:**

- The programming tone has been turned off with the hidden LOCK-OUT pad. Press and hold the LOCK-OUT pad for 3 or more seconds to turn the programming tone back on. (See page 12.)

### **2. If you need assistance\*...**

**Call Whirlpool COOL-LINE<sup>®</sup> service assistance telephone number. Dial free from:**  
**Continental U.S. .... (800) 253-1301**  
**Michigan ..... (800) 632-2243**  
**Alaska & Hawaii ..... (800) 253-1121**

and talk with one of our trained Consultants. The Consultant can instruct you in how to obtain satisfactory operation from your appliance or, if service is necessary, recommend a qualified service company in your area.

### 3. If you need service\*...



Whirlpool has a nationwide network of franchised TECH-CARE® Service Companies. TECH-CARE service technicians are trained to fulfill the product warranty and provide after-warranty service,

anywhere in the United States. To locate TECH-CARE service in your area, call our COOL-LINE service assistance telephone number (see Step 2) or look in your telephone directory Yellow Pages under:

**APPLIANCES - HOUSEHOLD -  
MAJOR - SERVICE & REPAIR**

WHIRLPOOL APPLIANCES  
FRANCHISED TECH-CARE SERVICE

*SERVICE COMPANIES*  
XYZ SERVICE CO  
123 MAPLE . . . . . 999-9999

**OR**

**ELECTRICAL APPLIANCES -  
MAJOR - REPAIRING & PARTS**

WHIRLPOOL APPLIANCES  
FRANCHISED TECH-CARE SERVICE

*SERVICE COMPANIES*  
XYZ SERVICE CO  
123 MAPLE . . . . . 999-9999

**OR**

**WASHING MACHINES, DRYERS  
& IRONERS - SERVICING**

WHIRLPOOL APPLIANCES  
FRANCHISED TECH-CARE SERVICE

*SERVICE COMPANIES*  
XYZ SERVICE CO  
123 MAPLE . . . . . 999-9999

### 4. If you have a problem\*...

Call our COOL-LINE service assistance telephone number (see Step 2) and talk with one of our Consultants, or if you prefer, write to:

Mr. Robert Stanley  
Division Vice President  
Whirlpool Corporation  
2000 US-33, North  
Benton Harbor, MI 49022

\*If you must call or write, please provide: model number, serial number, date of purchase, and a complete description of the problem. This information is needed in order to better respond to your request for assistance.



FSP is a registered trademark of Whirlpool Corporation for quality parts. Look for this symbol of quality whenever you need a replacement part for your Whirlpool appliance. FSP replacement parts

will fit right and work right, because they are made to the same exacting specifications used to build every new Whirlpool appliance.





Making your world a little easier.

Part No. 304270  
©1986 Whirlpool Corporation

Printed in U.S.A.

---

Makers, Dishwashers, Built-In Ovens, and Surface Units, Ranges, Microwave Ovens, Trash Compactors, Room Air Conditioners, Dehumidifiers, Automatic Washers, Clothes Dryers

